

BORDURES DE TROTTOIRS

Assemblage avaloir

Avaloir



Bavette

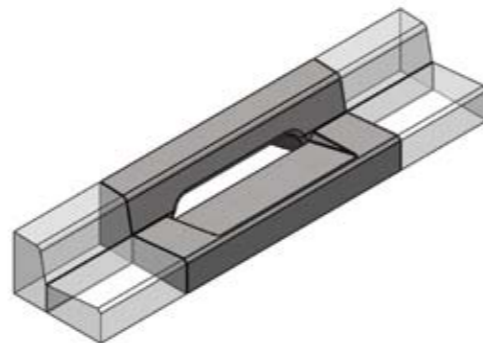
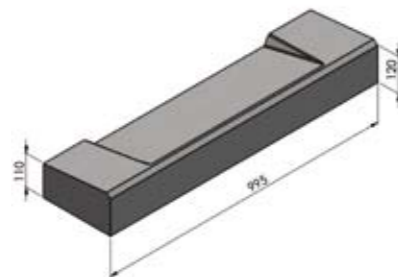

Bordures biaisées élément droit ou gauche

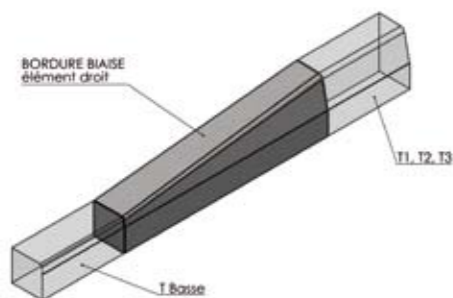

Les bordures existent en béton lavé et pressé.
Se reporter à la fiche nuancier pour visualiser notre offre.

POUR NOUS CONTACTER :

Email : Info@alkern.fr - Site web : www.alkern.fr

POURQUOI FAIRE APPEL À ALKERN ?

- **Plus de 50 ans d'expérience** dans la fabrication de produits en béton préfabriqué
- **Un savoir-faire** depuis la voirie, l'assainissement, le mobilier urbain jusqu'à l'univers du bâtiment et de l'aménagement extérieur
- **Nos équipes à vos côtés** : du technico-commercial à notre maçon démonstrateur, en passant par les Bureaux d'Etudes, guides de mise en oeuvre
- **Notre innovation** au service de vos projets
- **Notre engagement qualité** pour votre sérénité



alkern@wamido.fr
Photos non contractuelles - 05-2021

ALKERN

BORDURES
T1 - T2
T3 - T4



LES SOLUTIONS ALKERN pour la voirie

BORDURES DE TROTTOIRS
ET ACCESSOIRES



www.alkern.fr

BORDURES DE TROTTOIRS

Bordures T 1 - T 2 - T 3 - T 4

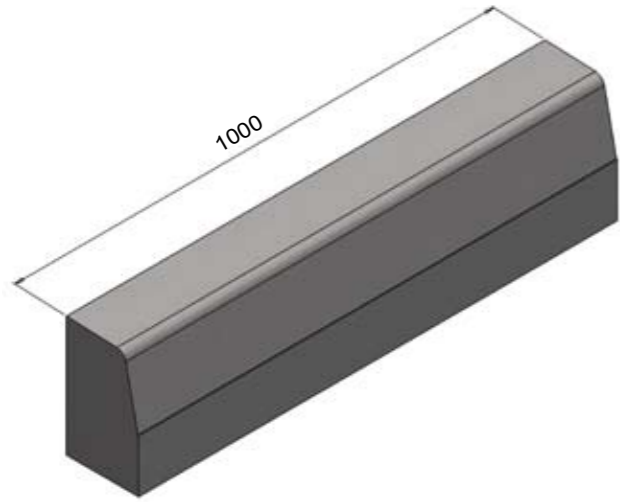

T 1
54 kg

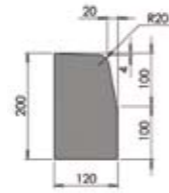

T 2
83 kg



T 3
107 kg

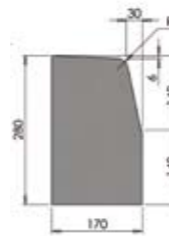

T 4
136 kg

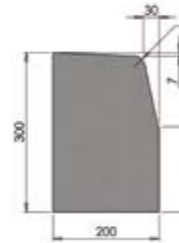

Accessoires bordures T 1

Avaloir T 1
83 Kg

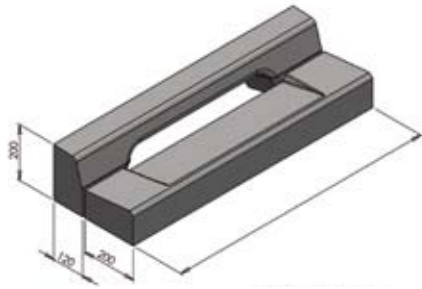

T 1 angle ext. coupé *
100 Kg

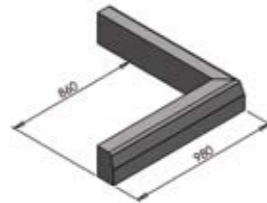

T 1 angle int. coupé *
98 Kg

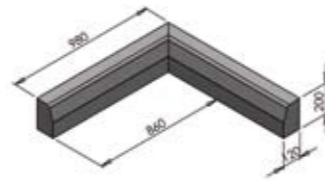

Accessoires bordures T 2

Avaloir T 2
126 Kg

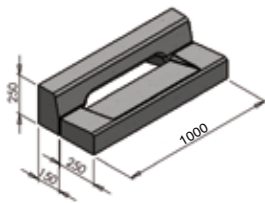

T 2 angle ext. coupé *
151 Kg

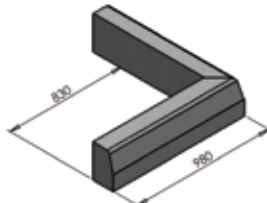

T 2 angle int. coupé *
152 Kg

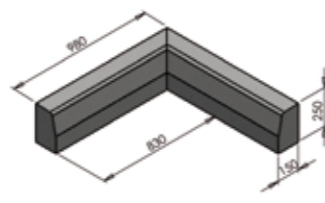

T 2 angle int. moulé
22 Kg



Accessoires bordures T 2

T 2 angle ext. moulé
19 Kg



T 2 courbe
55 Kg

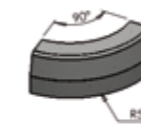

Raccord T 2 / T2 basse
69 Kg

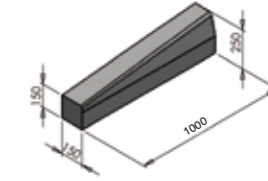

Raccord T 2 / A 2
75 Kg

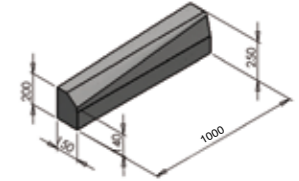

Raccord T2/T2 surbaissée
68 Kg

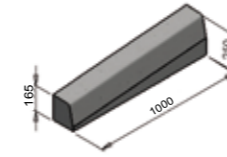

T 2 basse
53 Kg

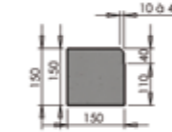

T 2 surbaissée
52 Kg

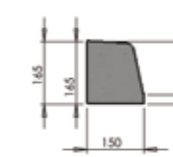

Accessoires bordures T 3

Avaloir T 3
141 Kg

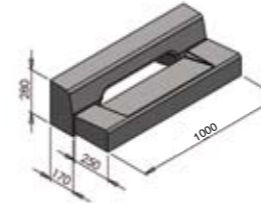

T 3 angle ext. coupé*
192 Kg

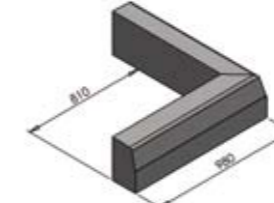

T 3 angle int. coupé*
194 Kg

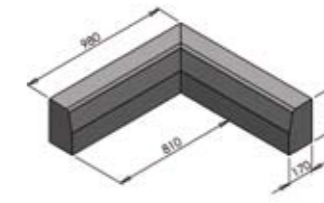

T 3 angle int. moulé
98 Kg

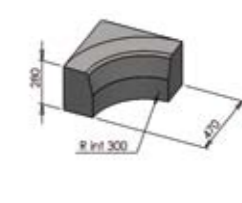

T 3 angle sortant
98 Kg

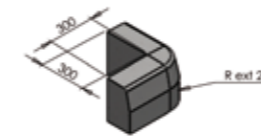

T 3 courbe
70 Kg



Raccord T 3 / T 3 basse
92 Kg

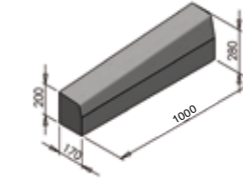

Raccord T 3 / A 2
87 Kg

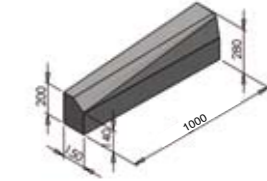

T 3 basse
77 Kg

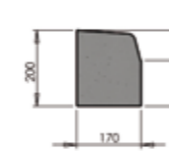

T 3 surbaissée
78 Kg

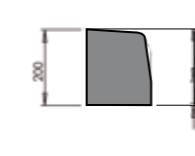

* Produit composé de 2 éléments.