

# ÉVIERS INOX





Pour les éviers inox, nous utilisons systématiquement de l'acier inoxydable AISI 304 haute performance et qualité. Ce type d'acier contient une quantité significative de chrome, et suffisamment de nickel pour stabiliser la microstructure. La composition typique est 18 % Chrome et 10 % nickel, ce qui rend les éviers résistants à la rouille ou à la corrosion dans des conditions d'utilisation normales. Cet inox est parfaitement adapté aux usages alimentaires. Finitions: lisse, brossé, anti rayures et micro déco.

## EASY FIX

---

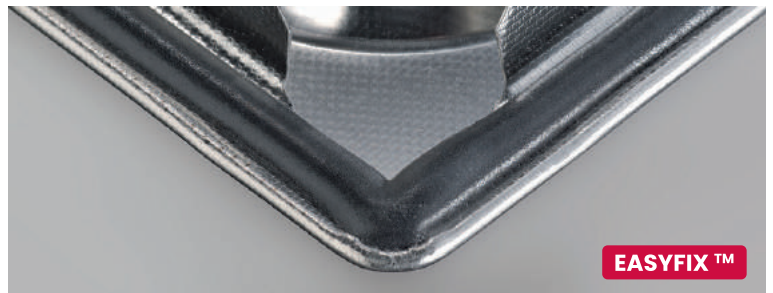



**LES ÉVIERS INOX ENCASTRABLES  
SONT FOURNIS AVEC UN JOINT DE  
POLYURÉTHANE MONTÉ EN USINE.**

De ce fait, l'installation des éviers à encastrer devient bien plus facile, le joint déjà présent permet de gagner du temps.

# CRI 1 CUVE



-  Inox lisse  
Réf: CR1PB9
-  Inox anti-rayure  
Réf: CR1ARNU

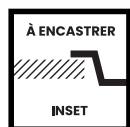

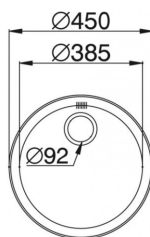

## CARACTERISTIQUES PRODUIT

Bonde	Bonde inox 90 mm
Siphon / Vidage inclus	Non, en option Réf. VM1TPV
Dimensions évier	Ø 450 mm
Dimensions des cuves	Ø 385 x 150 mm
Dimensions de découpe	430 mm
Dimensions de meuble minimum	450 mm
Cuve(s)	1 Cuve



# KIBA 1 CUVE



-  Inox lisse  
Réf: KIBAPNU
-  Inox anti-rayure  
Réf: KIBAARNU

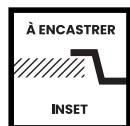

## CARACTERISTIQUES PRODUIT

Bonde	Bonde inox 90 mm
Siphon / Vidage inclus	Non, en option Réf. VM1TPV
Dimensions évier	Ø 485 mm
Dimensions des cuves	Ø 385 x 150 mm
Dimensions de découpe	465 mm
Dimensions de meuble minimum	450 mm
Cuve(s)	1 Cuve

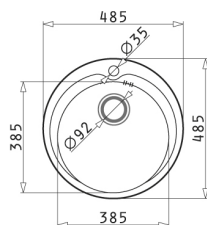

# CEB 1 CUVE



Inox lisse  
Réf: CEB2PB9NU

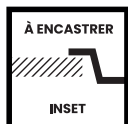

## CARACTERISTIQUES PRODUIT

Bonde	Bonde 90 mm
Siphon / Vidage inclus	Non, en option Réf. VM1TPV
Dimensions évier	465 x 435 mm
Dimensions des cuves	365 x 335 x 150 mm
Dimensions de découpe	445 x 415 mm
Dimensions de meuble minimum	400 mm
Cuve(s)	1 Cuve

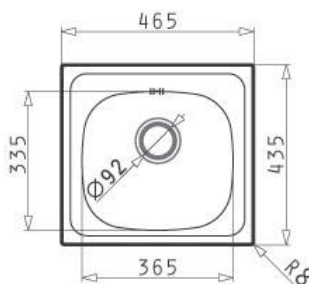

# KIBA 1 CUVE



Inox lisse  
Réf: KIBASNU

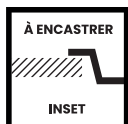

## CARACTERISTIQUES PRODUIT

Bonde	Bonde 90 mm
Siphon / Vidage inclus	Non, en option Réf. VM1TPV
Dimensions évier	465 x 405 mm
Dimensions des cuves	400 x 340 x 150 mm
Dimensions de découpe	445 x 385 mm
Dimensions de meuble minimum	450 mm
Cuve(s)	1 Cuve

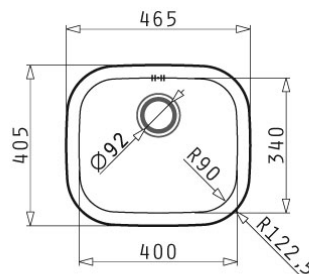

Besoin d'une fiche produit, d'une notice ?  
Rendez-vous sur [www.nord-inox-pro.fr](http://www.nord-inox-pro.fr) ou scannez moi.

# LUME 1 CUVE | 40 X 40 CM



Inox brossé  
Réf: LUME40EVC

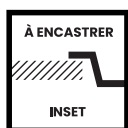

## CARACTERISTIQUES PRODUIT

Bonde	Bonde inox carrée 90 mm
Siphon / Vidage inclus	Oui
Dimensions évier	440 x 440 mm
Dimensions des cuves	400 x 400 mm
Dimensions de découpe	428 x 428 mm
Dimensions de meuble minimum	450 mm
Cuve(s)	1 Cuve

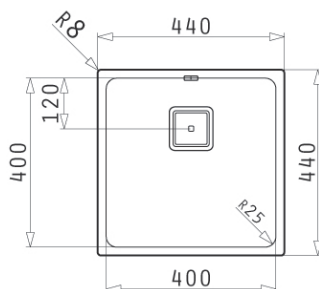

# LUME 1 CUVE 50 X 40 CM



Inox brossé  
Réf: LUME50EVC

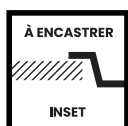

## CARACTERISTIQUES PRODUIT

Bonde	Bonde inox carrée 90 mm
Siphon / Vidage inclus	Oui
Dimensions évier	540 x 440 mm
Dimensions des cuves	500 x 400 mm
Dimensions de découpe	528 x 428 mm
Dimensions de meuble minimum	600 mm
Cuve(s)	1 Cuve

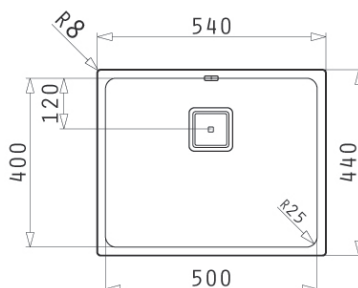

# SPARTA 1 CUVE



Inox lisse  
Réf. SPARTA6250PNU



## CARACTERISTIQUES PRODUIT

Bonde	Bonde 60 mm
Siphon / Vidage inclus	Non, en option Réf. V1TPVC
Réversible	Oui
Dimensions évier	620 x 500 mm
Dimensions des cuves	340 x 400 x 150 mm
Dimensions de découpe	600 x 480 mm
Dimensions de meuble minimum	450 mm
Cuve(s)	1 Cuve

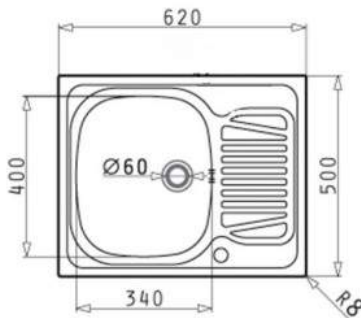

# SPARTA 1 CUVE

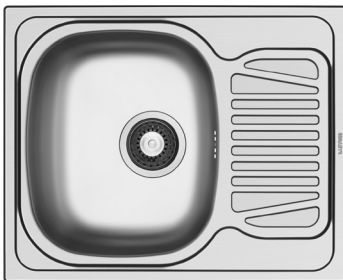

Inox anti-rayure  
Réf. SP6250AR92NU



## CARACTERISTIQUES PRODUIT

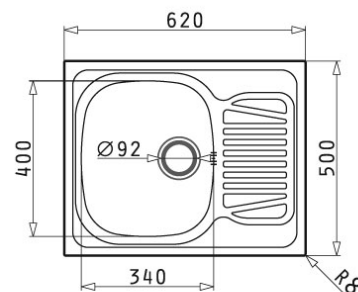

Bonde	Bonde 90 mm
Siphon / Vidage inclus	Non, en option Réf. V1TPVC
Réversible	Oui
Dimensions évier	620 x 500 mm
Dimensions des cuves	340 x 400 x 150 mm
Dimensions de découpe	600 x 480 mm
Dimensions de meuble minimum	450 mm
Cuve(s)	1 Cuve



Besoin d'une fiche produit, d'une notice ?  
Rendez-vous sur [www.nord-inox-pro.fr](http://www.nord-inox-pro.fr) ou scannez moi.

## E8 1 CUVE



-  Inox lisse  
Réf: E8PNU
-  Inox anti-rayure  
Réf: E8AR6NU



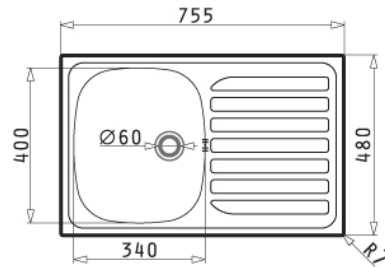

### CARACTERISTIQUES PRODUIT

Bonde	Bonde 60 mm
Siphon / Vidage inclus	Non, en option Réf. V1TPVC
Réversible	Oui
Dimensions évier	755 x 480 mm
Dimensions des cuves	340 x 400 x 150 mm
Dimensions de découpe	735 x 460 mm
Dimensions de meuble minimum	450 mm
Cuve(s)	1 Cuve



## E8 1 CUVE



-  Inox lisse  
Réf: E8P90NU
-  Inox anti-rayure  
Réf: E8AR90NU

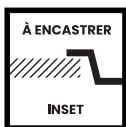

### CARACTERISTIQUES PRODUIT

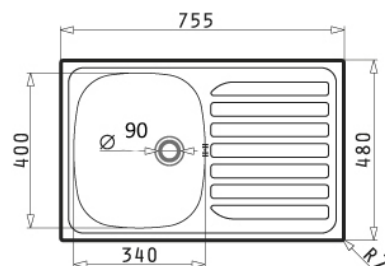

Bonde	Bonde 90 mm
Siphon / Vidage inclus	Non, option Réf. VM1TPV
Réversible	Oui
Dimensions évier	755 x 480 mm
Dimensions des cuves	340 x 400 x 150 mm
Dimensions de découpe	735 x 460 mm
Dimensions de meuble minimum	450 mm
Cuve(s)	1 Cuve





# ET78 1 CUVE



-  Inox lisse  
Réf: ET78PNU
-  Inox anti-rayure  
Réf: ET78AR6NU

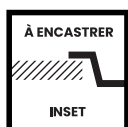

## CARACTERISTIQUES PRODUIT

Bonde	Bonde 60 mm
Siphon / Vidage inclus	Non, en option Réf. V1TPVC
Réversible	Oui
Dimensions évier	780 x 435 mm
Dimensions des cuves	365 x 335 x 150 mm
Dimensions de découpe	760 x 415 mm
Dimensions de meuble minimum	450 mm
Cuve(s)	1 Cuve

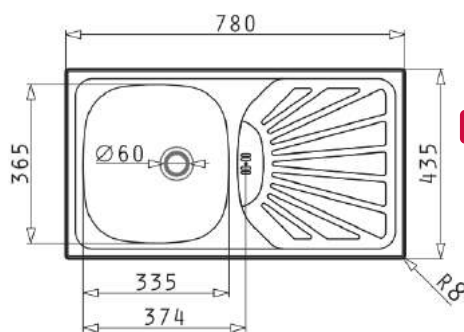

# FORK 1 CUVE



-  Inox lisse  
Réf: FORK1NU

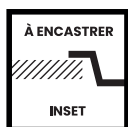

## CARACTERISTIQUES PRODUIT

Bonde	Bonde 60 mm
Siphon / Vidage inclus	Non, option Réf. V1TPVC
Réversible	Oui
Dimensions évier	860 x 435 mm
Dimensions des cuves	365 x 335 x 150 mm
Dimensions de découpe	840 x 415 mm
Dimensions de meuble minimum	450 mm
Cuve(s)	1 Cuve

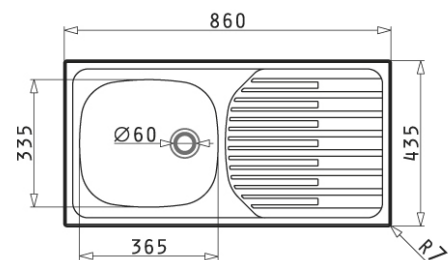



Besoin d'une fiche produit, d'une notice ?  
Rendez-vous sur [www.nord-inox-pro.fr](http://www.nord-inox-pro.fr) ou scannez moi.

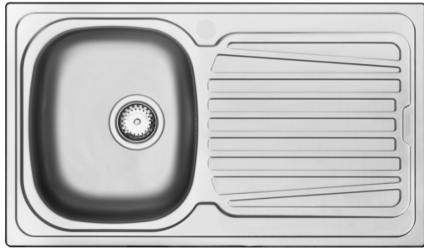

# SPARTA 1 CUVE



-  Inox lisse  
Réf: SPARTA1PMNU
-  Inox anti-rayure  
Réf: SPARTA1ARVMNU

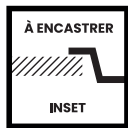

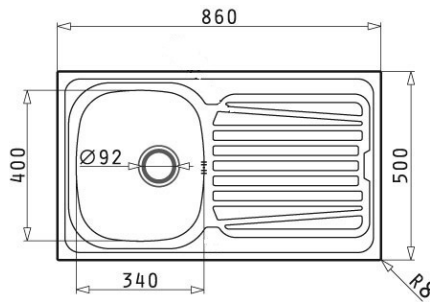

## CARACTERISTIQUES PRODUIT

Bonde	Bonde 90 mm
Siphon / Vidage inclus	Non, en option Réf. VM1TPV
Réversible	Oui
Dimensions évier	860 x 500 mm
Dimensions des cuves	340 x 400 x 150 mm
Dimensions de découpe	840 x 480 mm
Dimensions de meuble minimum	450 mm
Cuve(s)	1 Cuve



# PMR 1 CUVE



-  Inox lisse - Cuve à gauche  
Réf: ESFR1INOXNU
-  Inox lisse - Cuve à droite  
Réf: ESFR2INOXNU

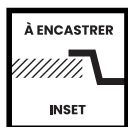

## CARACTERISTIQUES PRODUIT

Bonde	Bonde 60 mm
Siphon / Vidage inclus	Non, option Réf. V1TPVREP
Réversible	Non
Dimensions évier	940 x 490 mm
Dimensions des cuves	400 x 340 x 127 mm
Dimensions de découpe	920 x 470 mm
Dimensions de meuble minimum	450 mm
Cuve(s)	1 Cuve

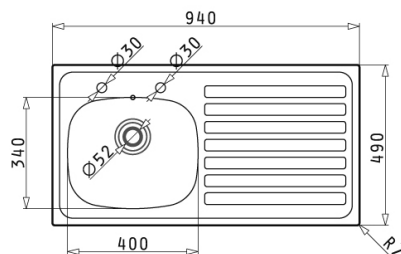

# DERBY 2 CUVES



Inox lisse  
Réf: DERBY2P6NU

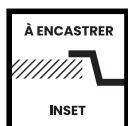

## CARACTERISTIQUES PRODUIT

Bonde	Bonde 60 mm
Siphon / Vidage inclus	Non, en option Réf. VA2TPVC
Réversible	Oui
Dimensions évier	1160 x 500 mm
Dimensions des cuves	340 x 400 x 150 mm
Dimensions de découpe	1140 x 480 mm
Dimensions de meuble minimum	800 mm
Cuve(s)	2 Cuves

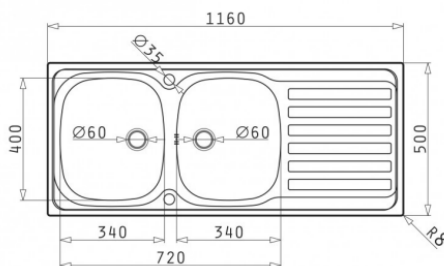

# SPARTA 2 CUVES

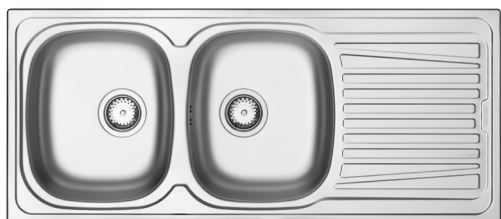

Inox lisse  
Réf: SPARTA2PMNU

Inox anti-rayure  
Réf: SPARTA2ARVMNU

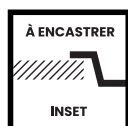

## CARACTERISTIQUES PRODUIT

Bonde	Bonde 90 mm
Siphon / Vidage inclus	Non, option Réf. VM105TPV
Réversible	Oui
Dimensions évier	1160 x 500 mm
Dimensions des cuves	340 x 400 x 150 mm
Dimensions de découpe	1140 x 480 mm
Dimensions de meuble minimum	800 mm
Cuve(s)	2 Cuves

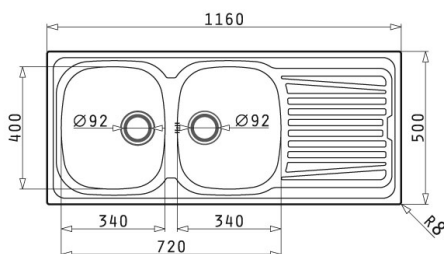

Besoin d'une fiche produit, d'une notice ?  
Rendez-vous sur [www.nord-inox-pro.fr](http://www.nord-inox-pro.fr) ou scannez moi.