

## ACCESSORIES

### Car Adapter

Enables you to re-charge your battery with your vehicle's electrical system.



Part No. 900507

### Battery Cell

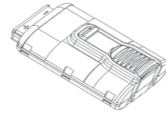

Part No. 018880

### Battery Charger

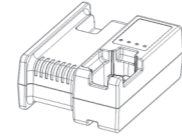

Part No. 018881 (EU)  
018883 (ANZ)

### Cable

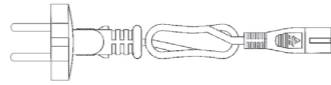

Part No. 018885 (EU)  
018887 (ANZ)

### Hex Key

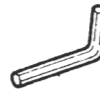

Part No. 401331

### Safety Glasses



Part No. 014121

### Paslode Intensive Tool Cleaner 300 ml

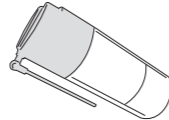

Part No. 115251

### Paslode Impulse Lubricating Oil

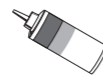

Part No. 013075

### Carrying Case Standard



Part No. 014977

### Specific Probes

Part No. 019783

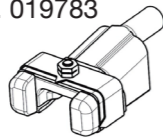

Part No. 019784

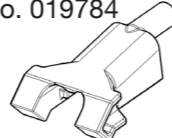

Part No. 019785

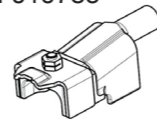

### Standard magazine

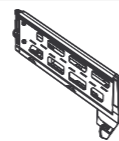

Part No. 019766

### Cleaning Kit (Blister)

Contains all the necessary to clean any Impulse tool



Part No. 013690

### Maintenance Kit

(Filter + o'ring)



Part No. 013231



An Illinois Tool Works Company  
150, Route de Lyon  
F - 26500 Bourg-lès-Valence - France

019694-5 10/21

# Paslode®

## Impulse®

Part No. 019710 (EU)  
Part No. 019705 (ANZ)



# IM90Xi

### IMPORTANT! DO NOT DESTROY

Always refer to operating and safety instructions (#019690 & #014749) for detailed information on this tool. It is the customer's responsibility to have all operators and service personnel read and understand this information.

## TOOL SCHEMATIC AND PARTS

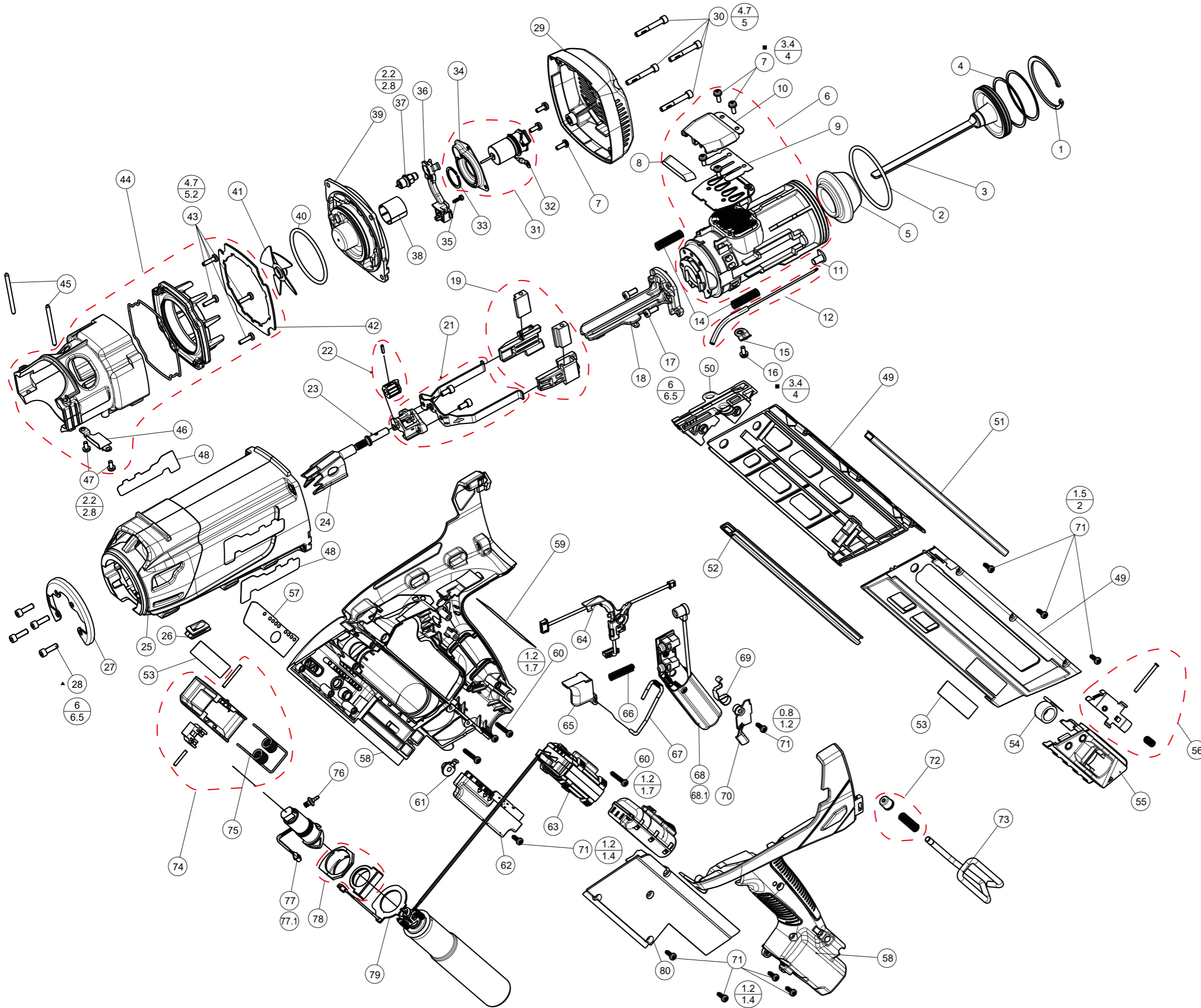

REP	CODE	QUANTITY	DESCRIPTION
1	336680	1	RETAINER RING
2	013743	1	CYLINDER O'RING
3	019296	1	PISTON ASSEMBLY
4	336670	2	PISTON RING
5	013778	1	BUMPER
6	019292	1	CYLINDER ASSEMBLY
7	900596	5	SCREW SWAGE FORM 4-11
8	336570	1	MUFFLER
9	336560	1	REED VALVE
10	336580	1	MUFFLER COVER
11	019283	1	COMBUSTION CHAMBER SPRING GUIDE
12	013737	1	INJECTION PIPE ASSEMBLY
14	019276	2	COMBUSTION CHAMBER SPRING GUIDE
15	013738	1	BRACKET FUEL LINE
16	900595	1	SCREW SWAGE FORM 4-9
17	019819	2	SCREW TORX 25 M5-12
18	019277	1	NOSE
19	019289	1	COMBUSTION CHAMBER BUMPER ASS.
21	019402	1	UPPER PROBE ASSEMBLY
22	019295	1	KNOB
23	019735	1	PROBE AXIS
24	019278	1	PROBE
25	019275	1	CARTER
26	013812	1	ELECTROVALVE HEAT PROTECTION
27	013787	1	NOSE PROTECTION
28	013813	4	SCREW CHC M5-16
29	019121	1	CAP
30	013797	4	SCREW CHC M5-35
31	019077	1	MOTOR ASSEMBLY
32	014771	1	FAN MOTOR GROUND WIRE
33	321610	1	RETAINING RING
34	334310	1	MOTOR MOUNT
35	404702	1	SCREW THREAD FORMING 6X3/8
36	013808	1	WIRES GUIDE
37	013731	1	SPARK PLUG ASSEMBLY
38	321590	1	MOTOR SLEEVE
39	013740	1	CYLINDER HEAD
40	321650	1	CYLINDER O'RING
41	321660	1	FAN BLADE ASSEMBLY
42	013750	1	SEAL
43	900456	4	SCREW SWAGE FORM 4-15
44	019288	1	COMBUSTION CHAMBER ASSEMBLY
45	013781	2	COMBUSTION CHAMBER STOP PIN
46	019073	1	COMBUSTION CHAMBER LOCK OUT
47	013805	2	SCREW TAP TYPE 4X8
48	015000	2	CARTER LABEL
49	019291	1	MAGAZINE ASSEMBLY (LEFT & RIGHT )
50	013741	1	SHEAR BLOCK
51	013763	1	NAIL CHANNEL
52	019280	1	COVER PLATE MAGAZINE
53	014989	2	NAME TOOL LABEL
54	013767	1	MAGAZINE SPRING
55	019279	1	FOLLOWER ASSEMBLY
56	013762	1	FOLLOWER SUB ASSEMBLY
57	014999	1	LEVELS LABEL
58	019297	1	HANDLES ASSEMBLY (LEFT & RIGHT )
59	014998	1	NAME PLATE LABEL
60	013799	4	SCREW ECO-SYN TORX 4X25
61	019089	1	POWER BUTTON
62	019091	1	DEL ASSEMBLY
63	019273	1	BATTERY TERMINAL ASSEMBLY
64	019286	1	WIRES ASSEMBLY
65	019119	1	TRIGGER
66	013783	1	TRIGGER SPRING
67	019084	1	COMBUSTION CHAMBER LOCK BAR
68	019096	1	RED S-MEFI
68-1	019097	1	BLACK S-MEFI
69	013734	1	CONTACT LEVEL
70	013785	1	CONTACTOR PLATE
71	013798	9	SCREW ECO-SYN TORX 4X12
72	019290	1	HOOK SPRING ASSEMBLY
73	019284	1	HOOK
74	019293	1	LOCK MAGAZINE SYSTEM
75	019285	1	SPRING LOCK MAGAZINE SYSTEM
76	013739	1	ELECTROVALVE PLUG CONNECTION
77	019116	1	RED ELECTROVALVE ASSEMBLY
77-1	019117	1	BLACK ELECTROVALVE ASSEMBLY
78	019088	1	EJECT BUTTON ASSEMBLY
79	019282	1	ANTENNA
80	019281	1	HANDLE COVER

TORQUE VALUES	
MIN	N.m
MAX	