

STOCKAGE DES LAMES

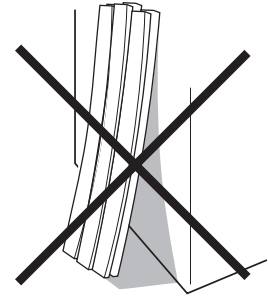

=

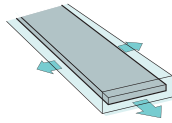

POSE DES TASSEaux

Classe 3B

27 mm
min
30 mm
min

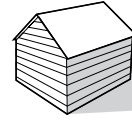
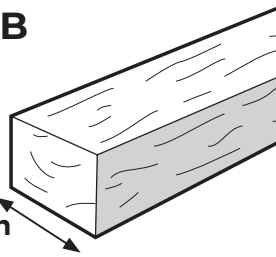

=

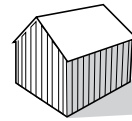
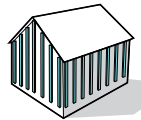

=

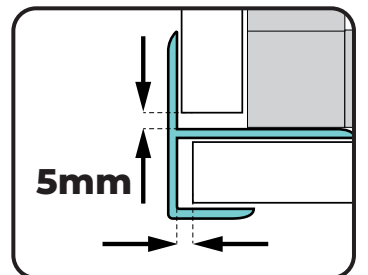
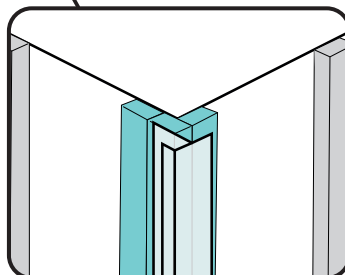
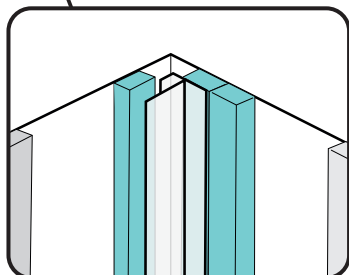
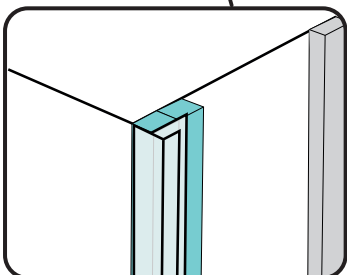
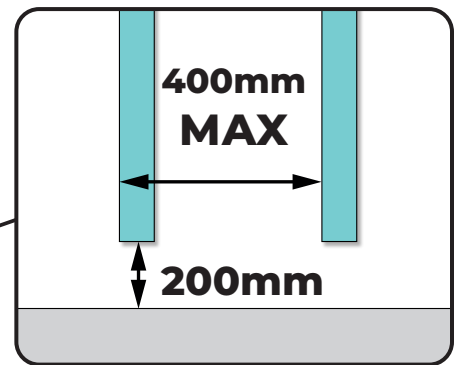
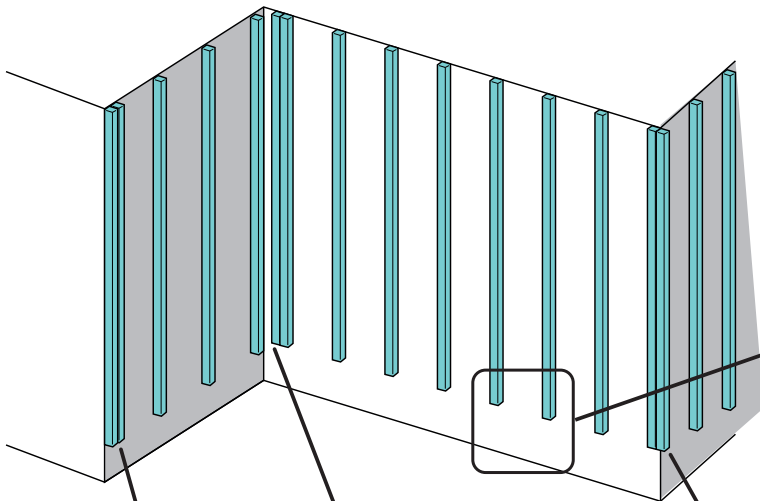
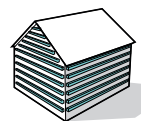

POSE DU BARDAGE

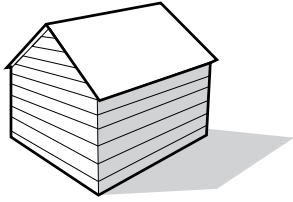

HORIZONTALE

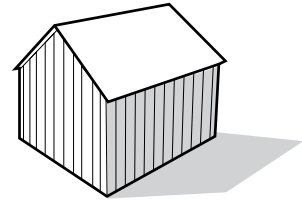

VERTICALE

ref :
SIBARFIN210x

3

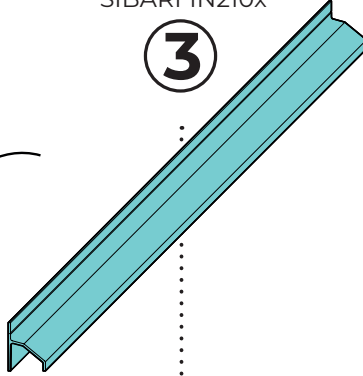

ref :
SIBARCLIP2111

2

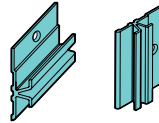

1

ref :
SIBARDEB2100

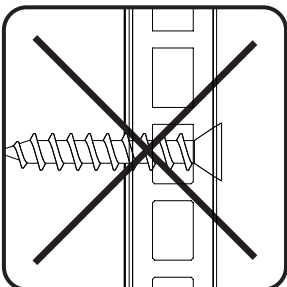
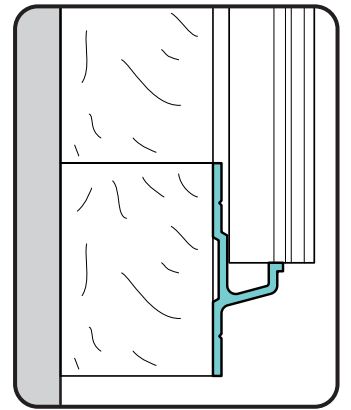
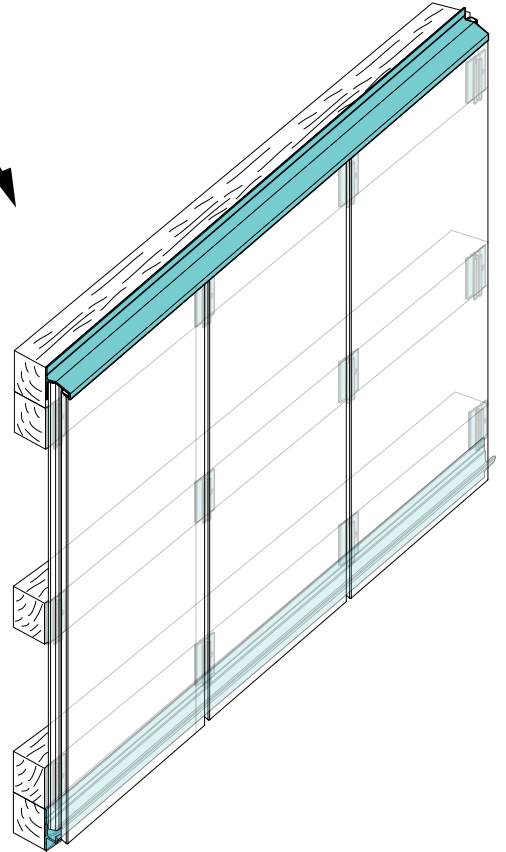
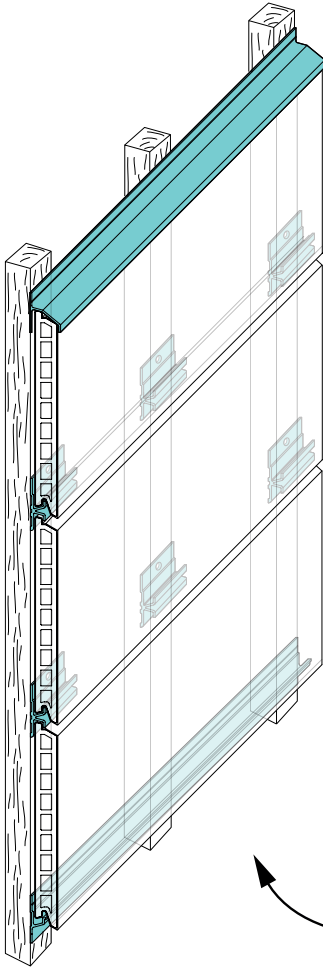
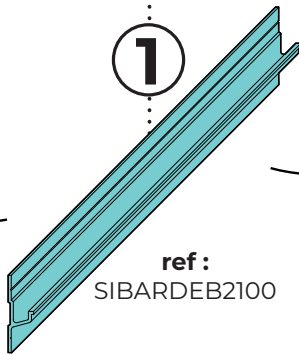

Voir Plan de montage

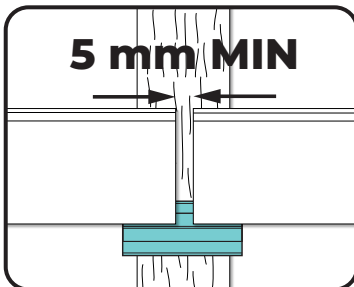

ref : SIBARCLIP2112

