

HI15F

1,5 m

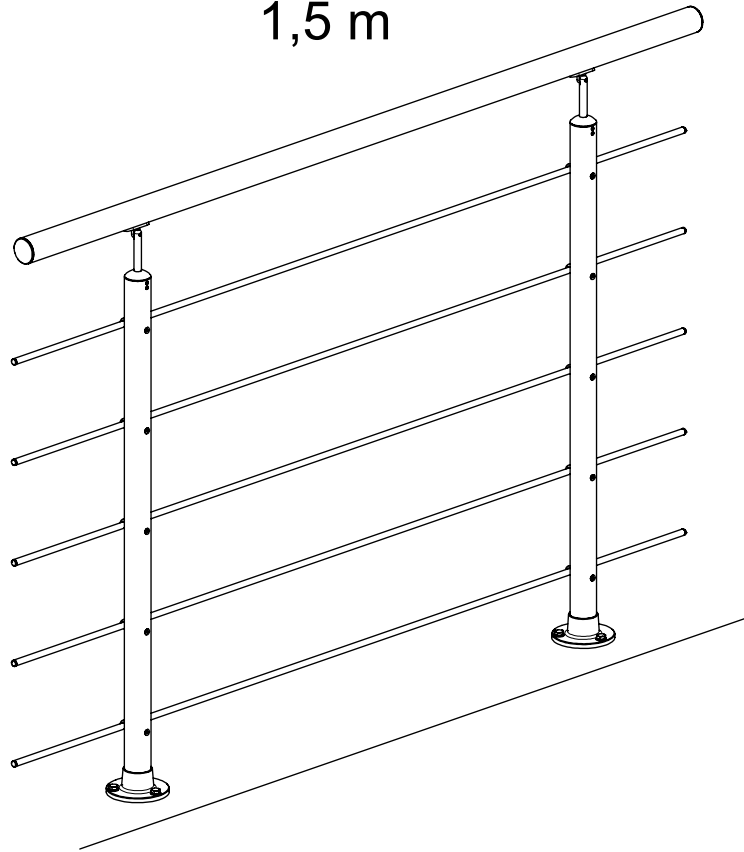

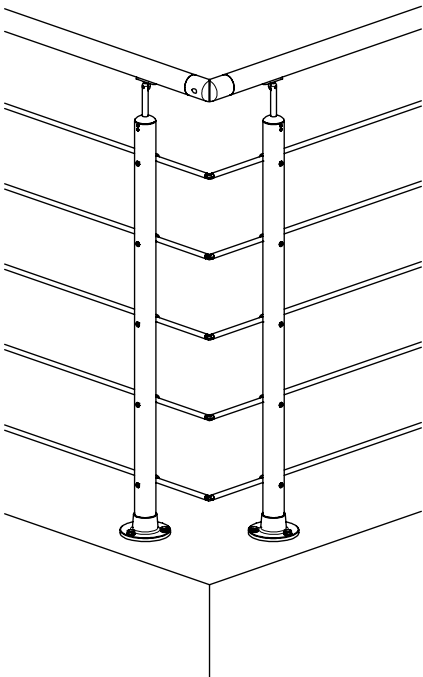





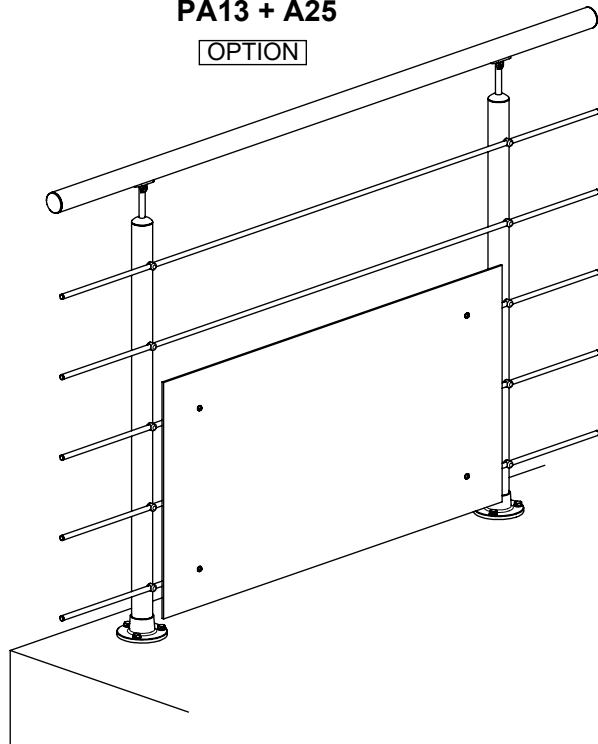

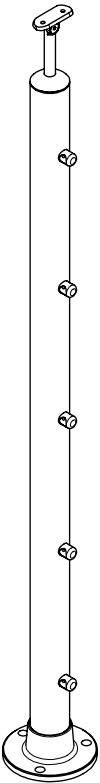

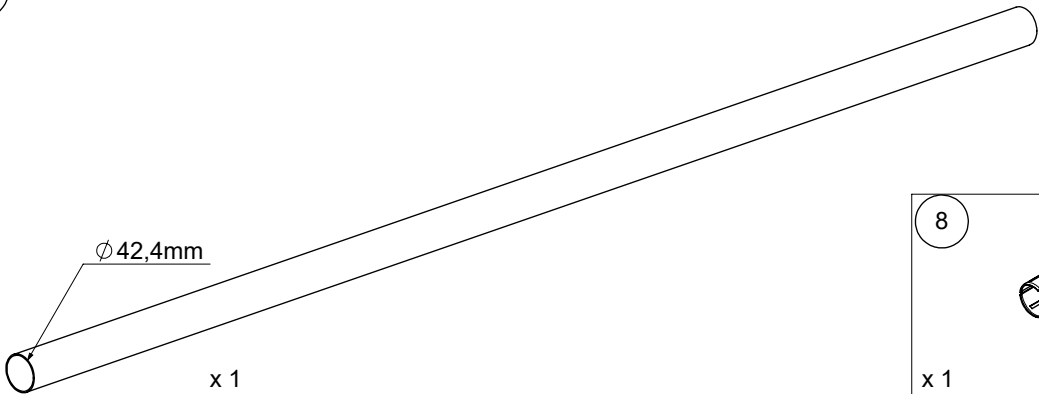

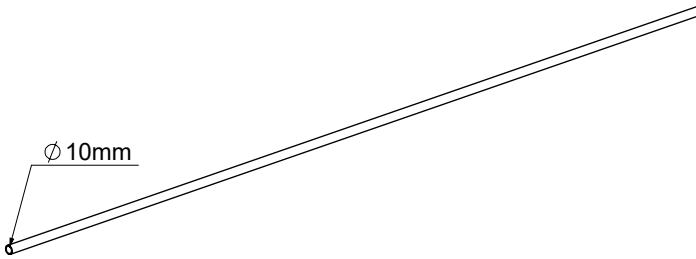
HIC
OPTION





PA13 + A25
OPTION

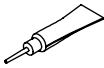

<p>1</p>  <p>x 2 K2-1085910</p>	<p>4</p>  <p>x 2 K1-35311</p>	<p>6</p>  <p>x 4 K3-02042 M4 x 12</p>	<p>HI15F</p>
<p>7</p>  <p>Ø 42,4mm</p> <p>x 1 K1-35301 1,5 m</p>		<p>8</p>  <p>x 1 K1-35330</p>	
<p>9</p>  <p>Ø 10mm</p> <p>x 5 K1-18049 1,5 m</p>		<p>10</p>  <p>x 5 K1-1092201</p>	<p>11</p>  <p>x 10 K1-18099</p>
<p>12</p>  <p>x 1 K3-10014 M4</p>		<p>13</p>  <p>x 1 K3-90001</p>	

<p>HIC OPTION</p>	
<p>8</p>  <p>x 2 K1-35330</p>	<p>13</p>  <p>x 1 K3-90001</p>
<p>20</p>  <p>x 1 K2-35340</p>	<p>21</p>  <p>x 5 K2-35426</p>

<p>HI13 OPTION</p>	
<p>30</p>  <p>x 4 K1-1085998</p>	
<p>31</p>  <p>x 8 K1-36047</p>	
<p>32</p>  <p>x 4 K3-02266 M6 x 12</p>	

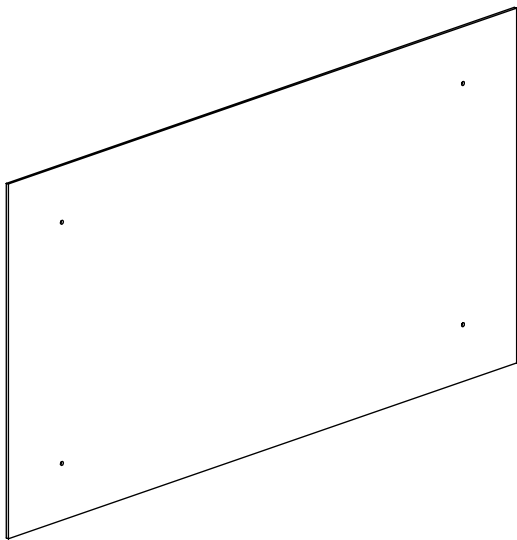
<p>A25 OPTION</p>	
 <p>Verre acrylique Ackrylglas Vidrio acrílico</p>	

1

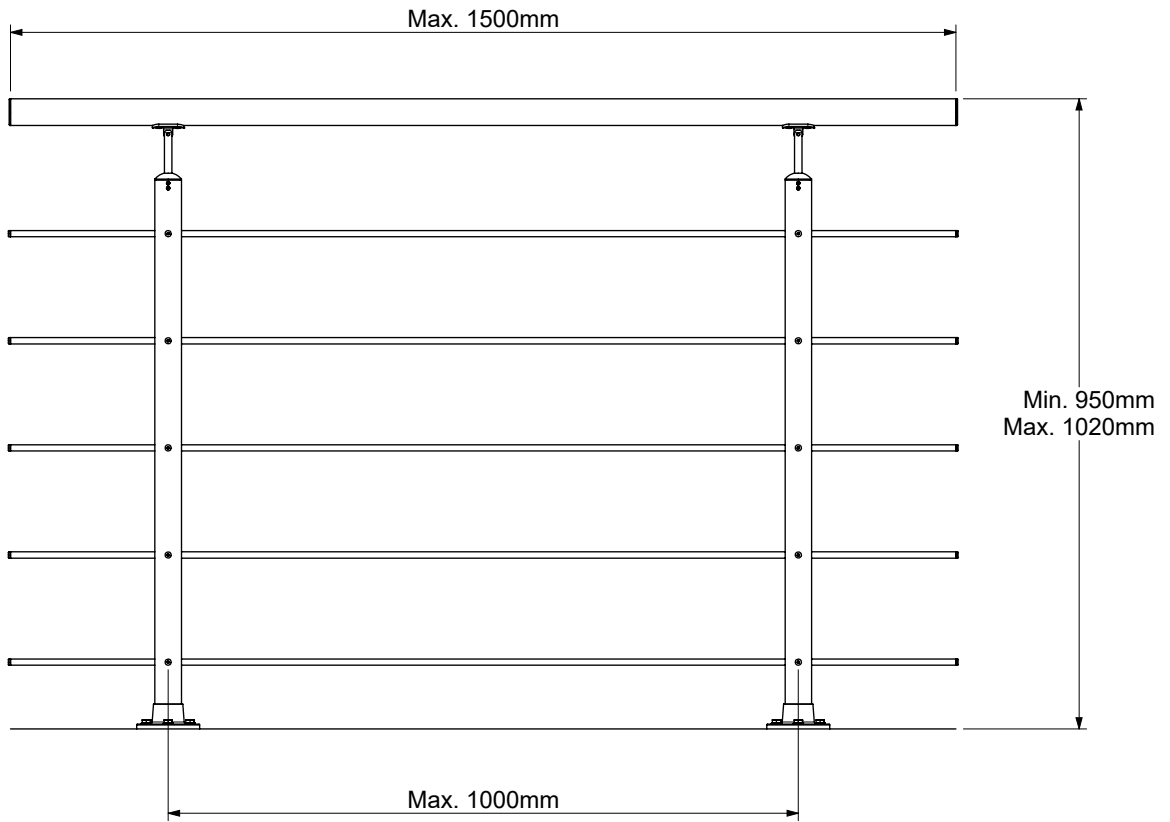

2

Alt A



1

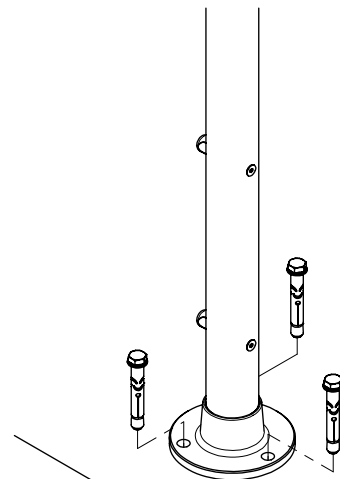
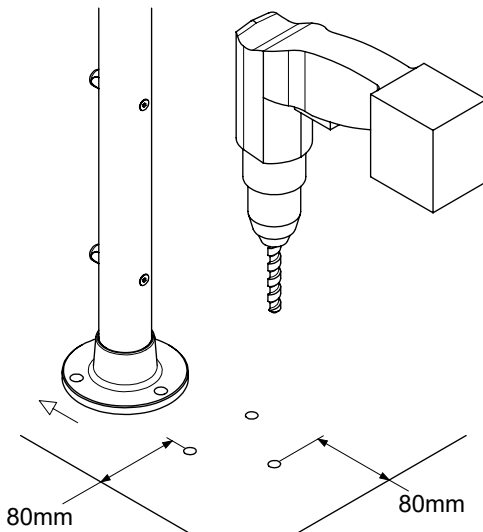
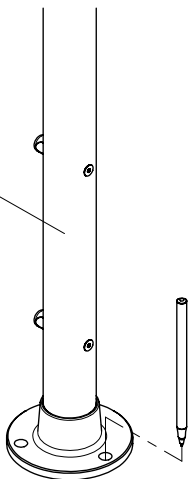

2

Alt B



1

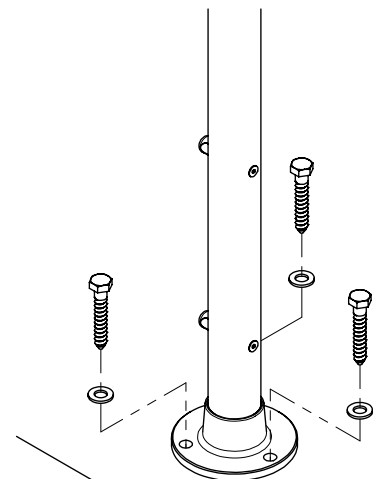
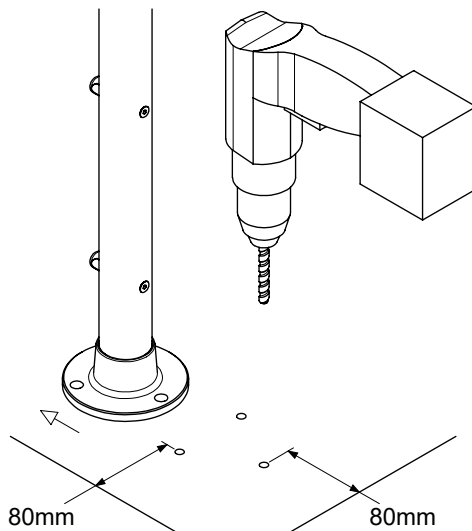
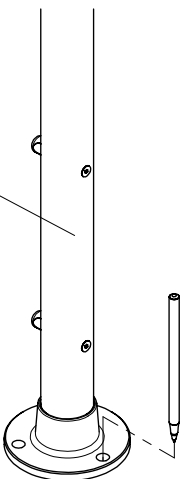

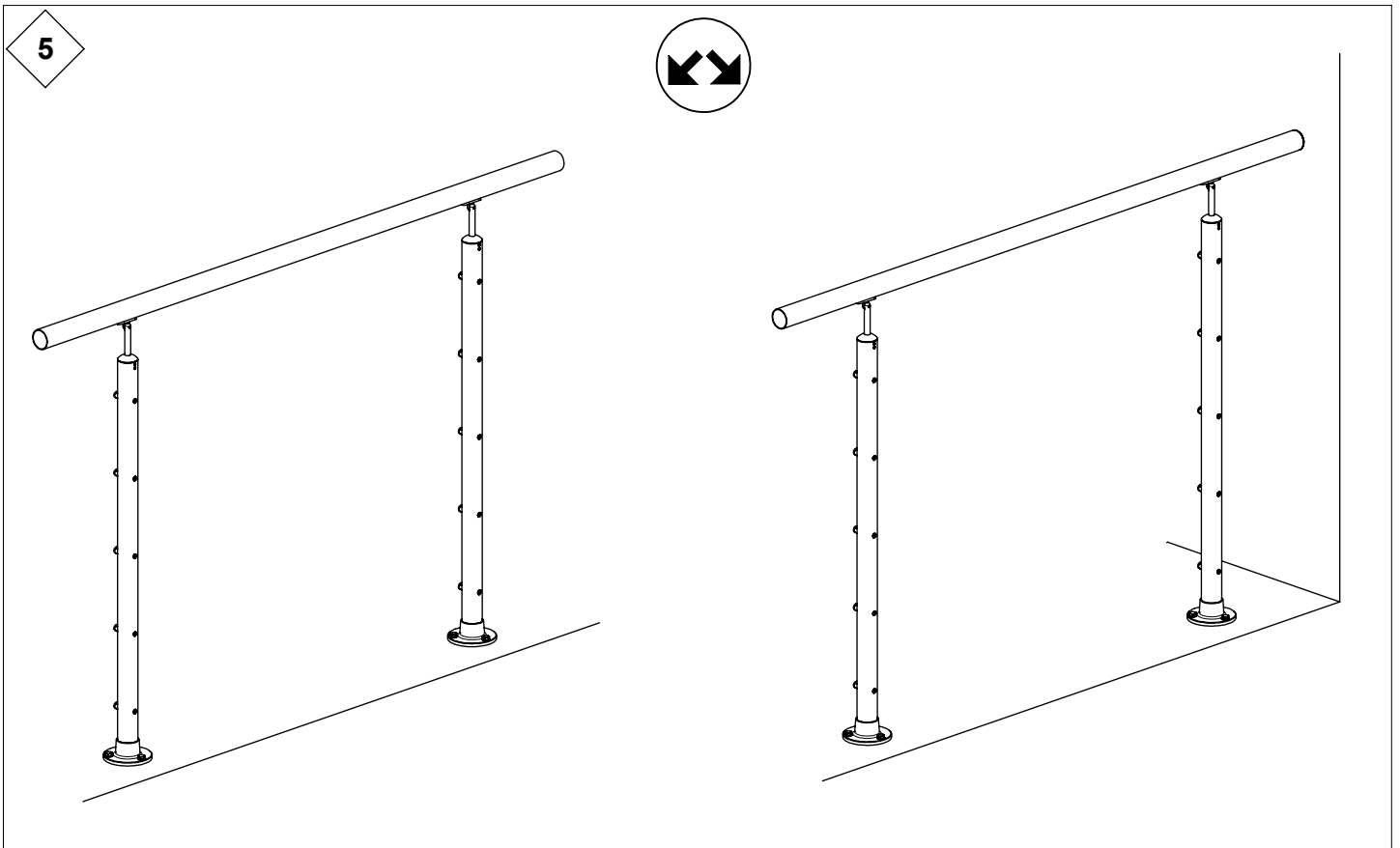
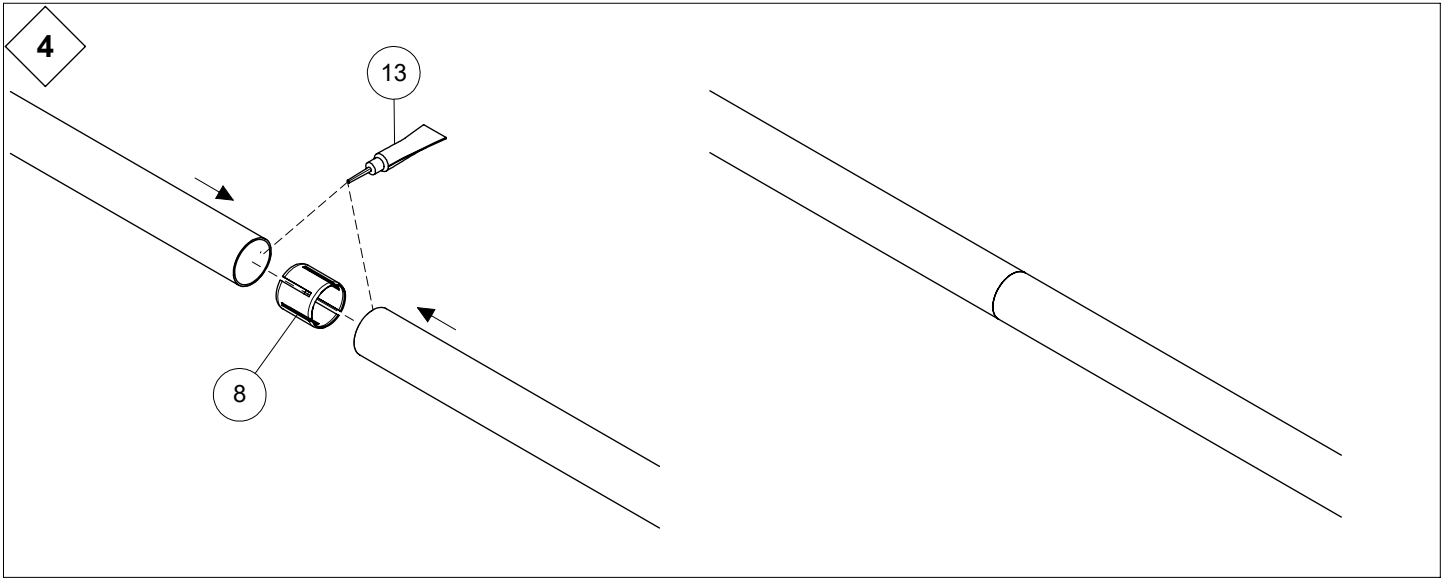
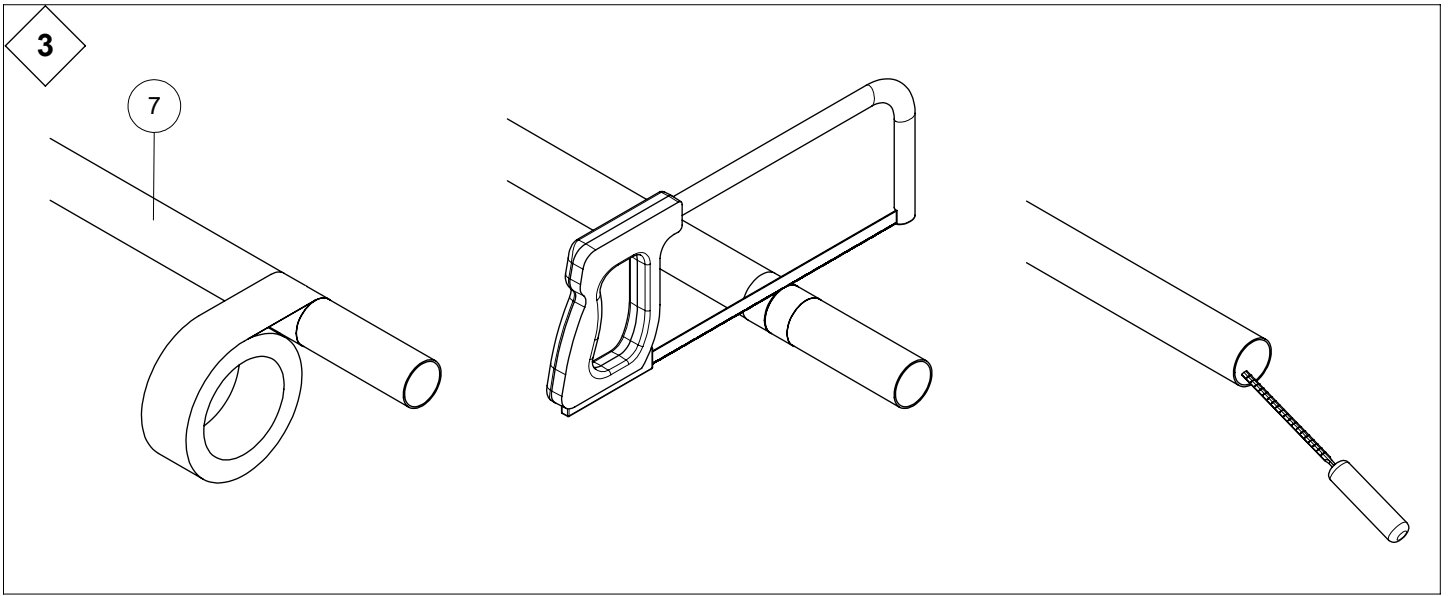

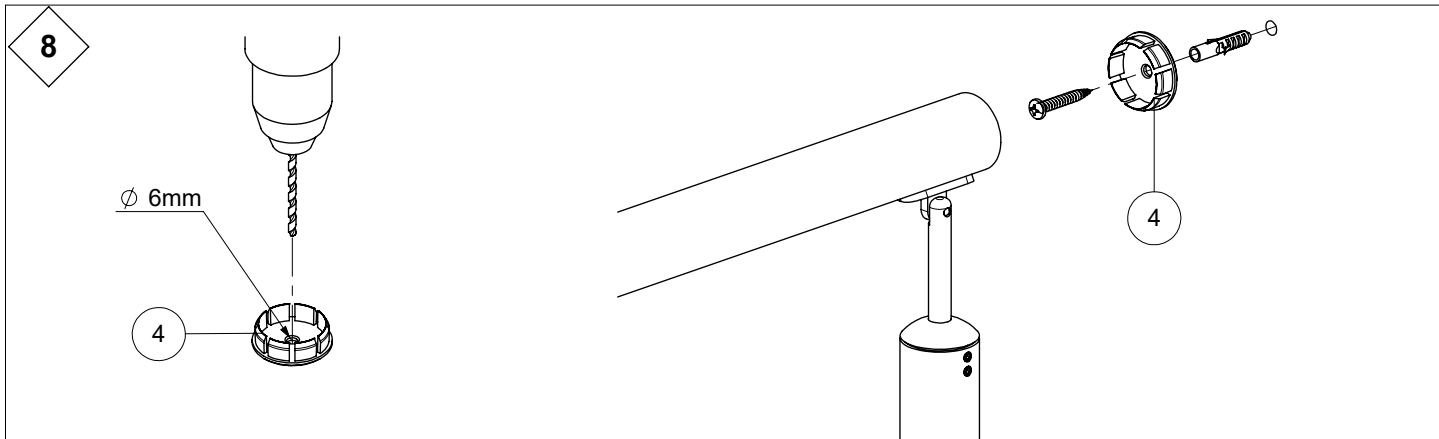
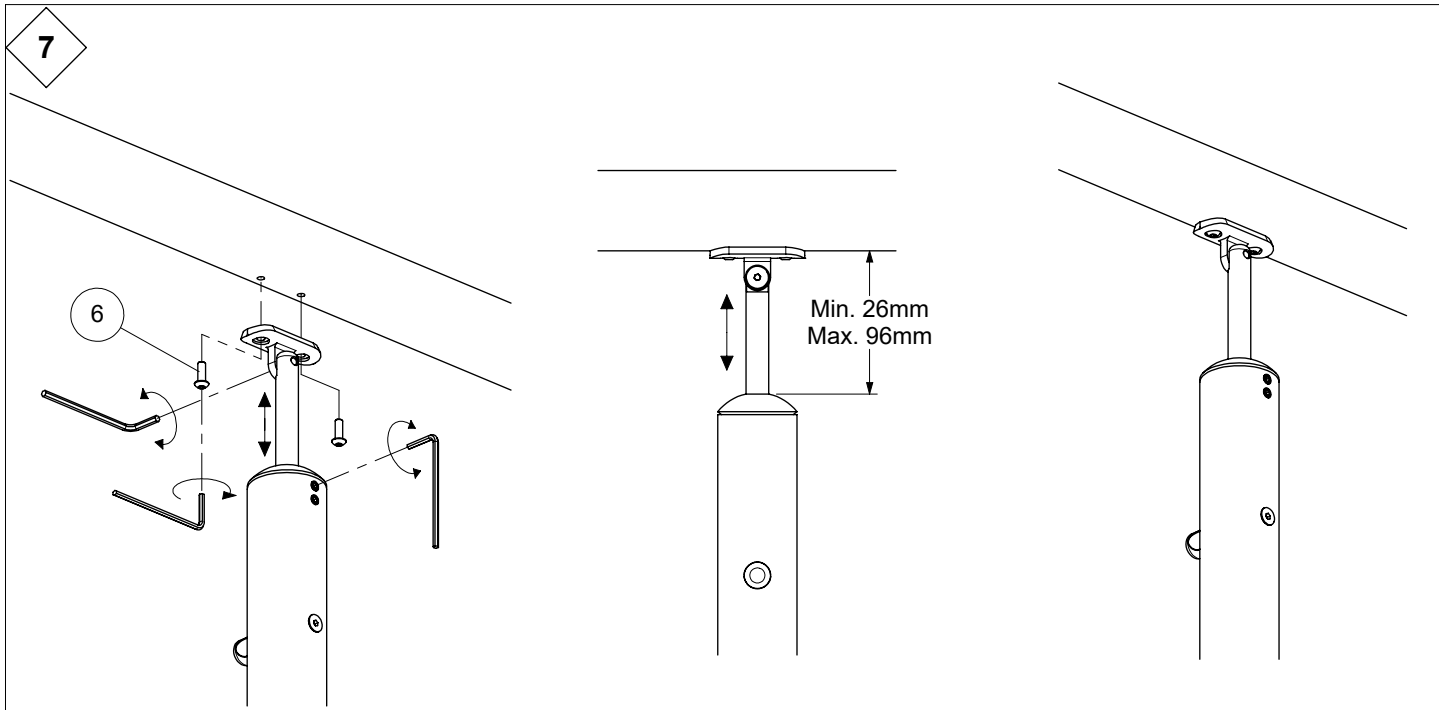
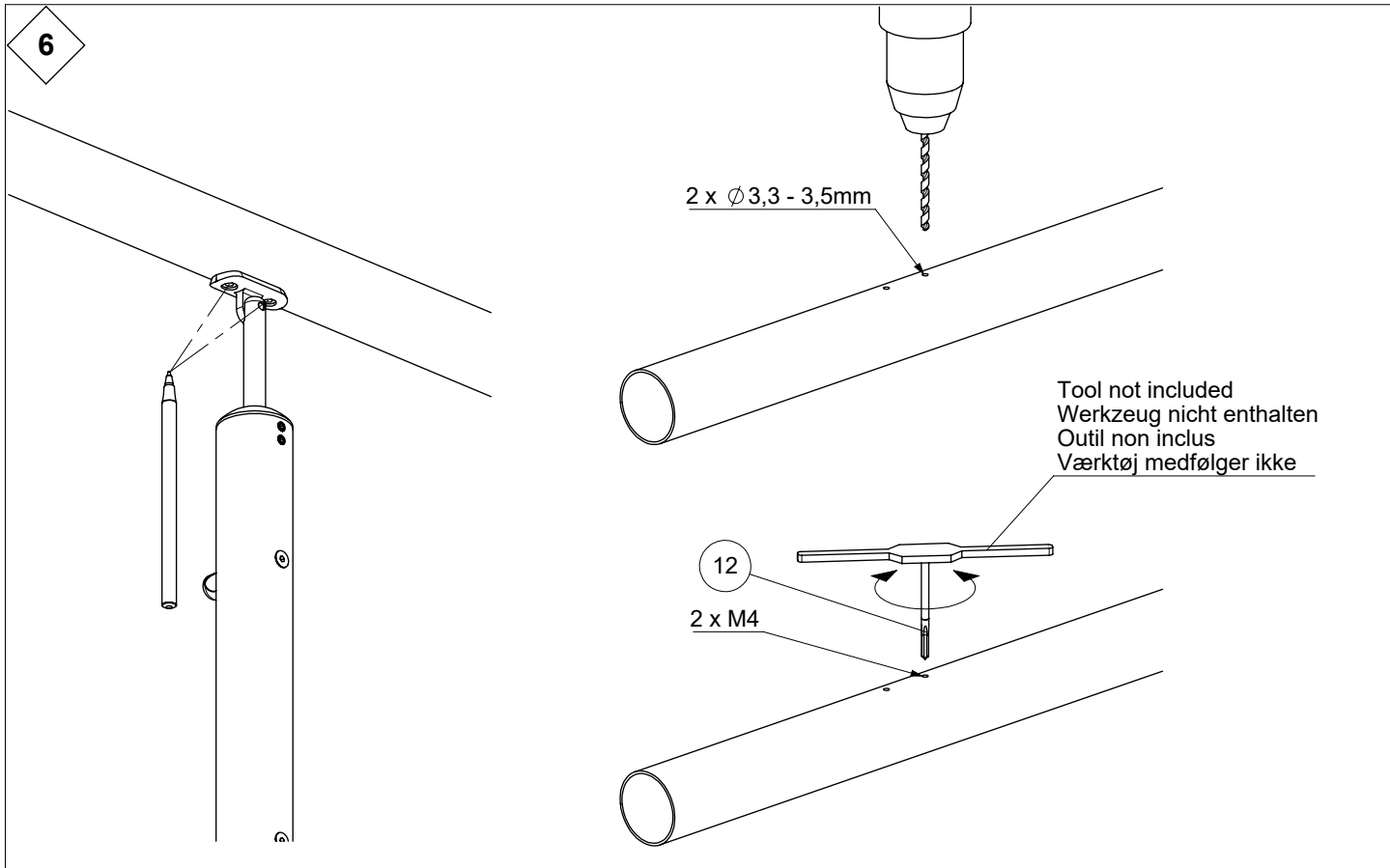

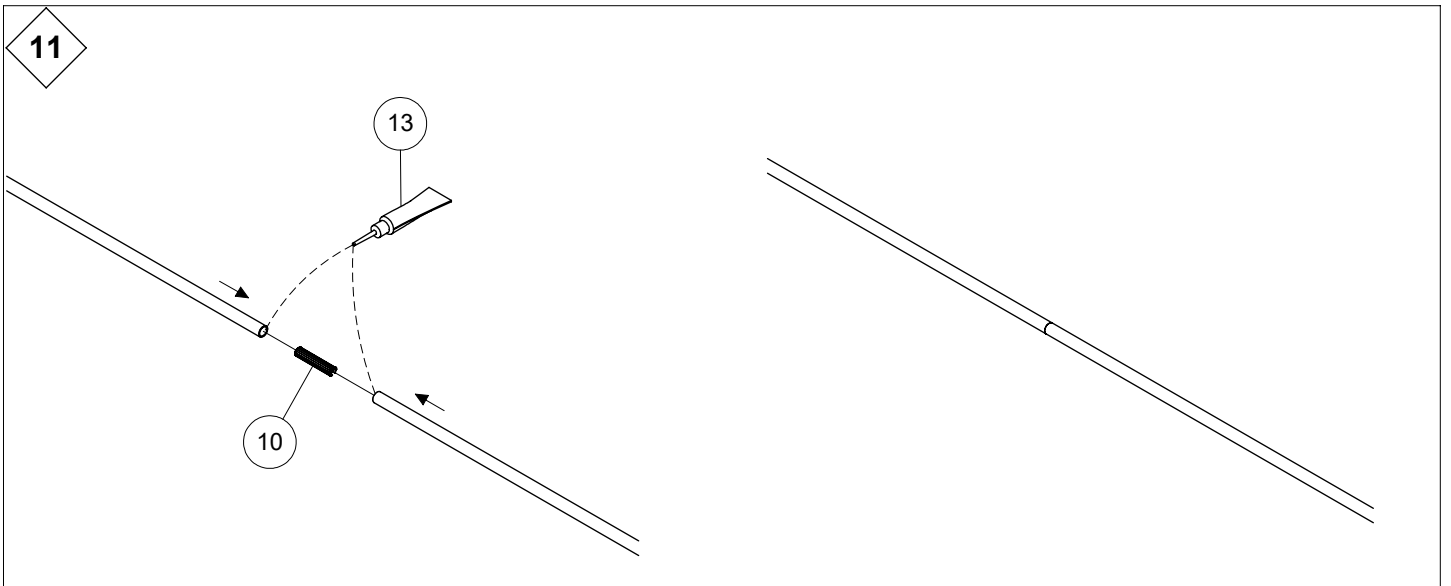
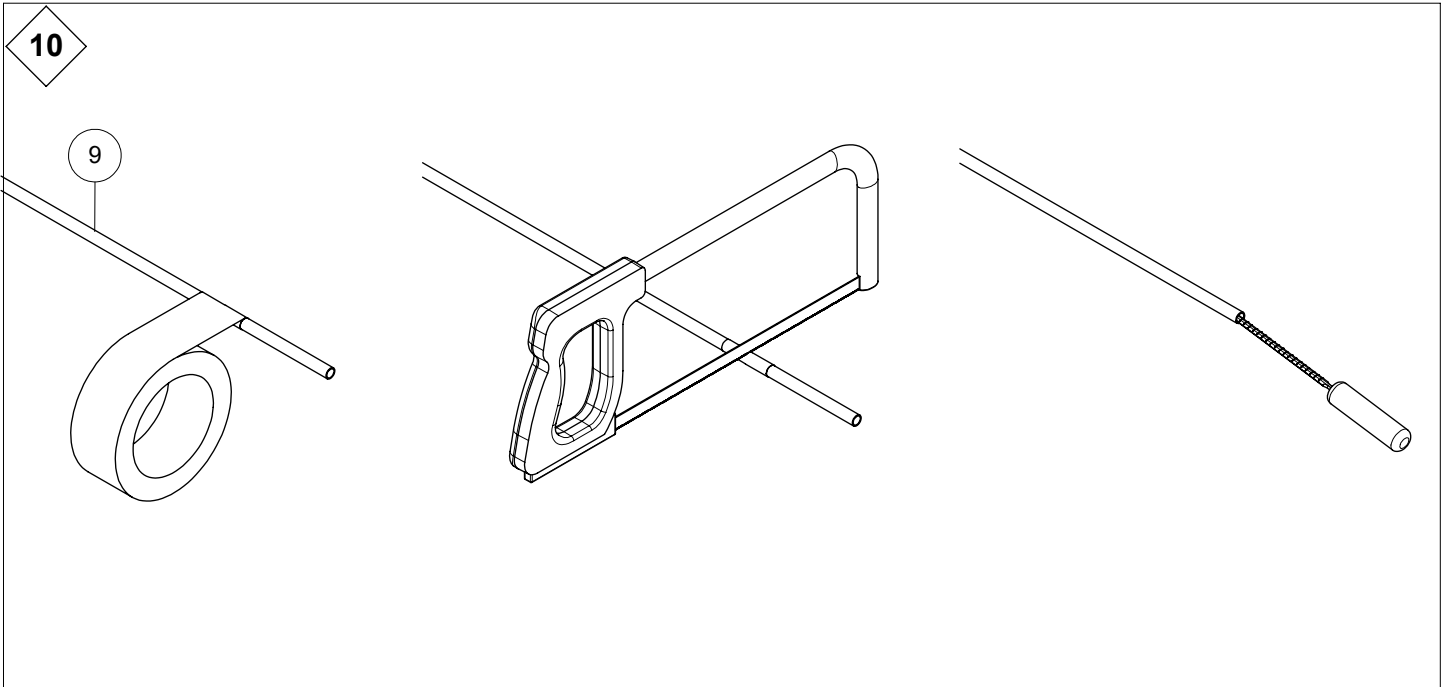
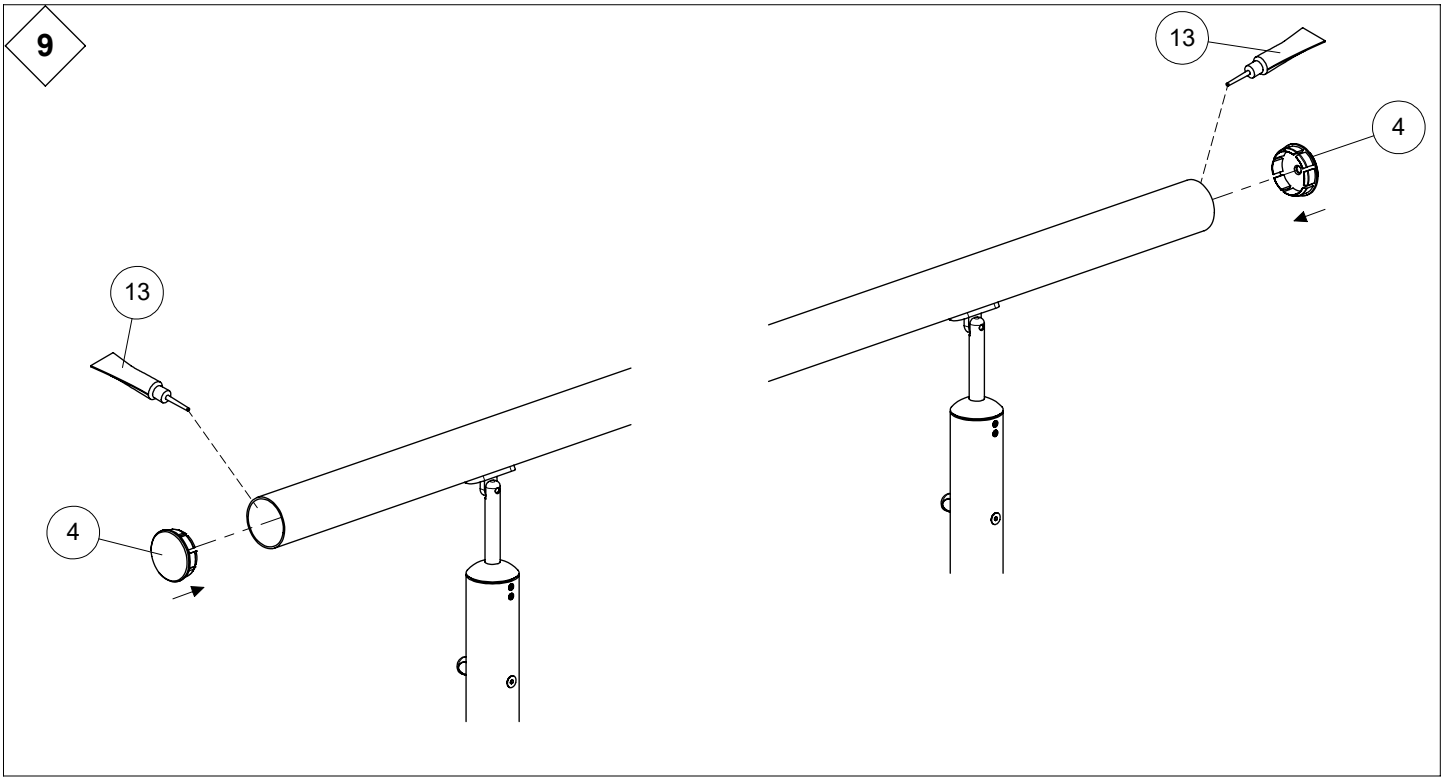

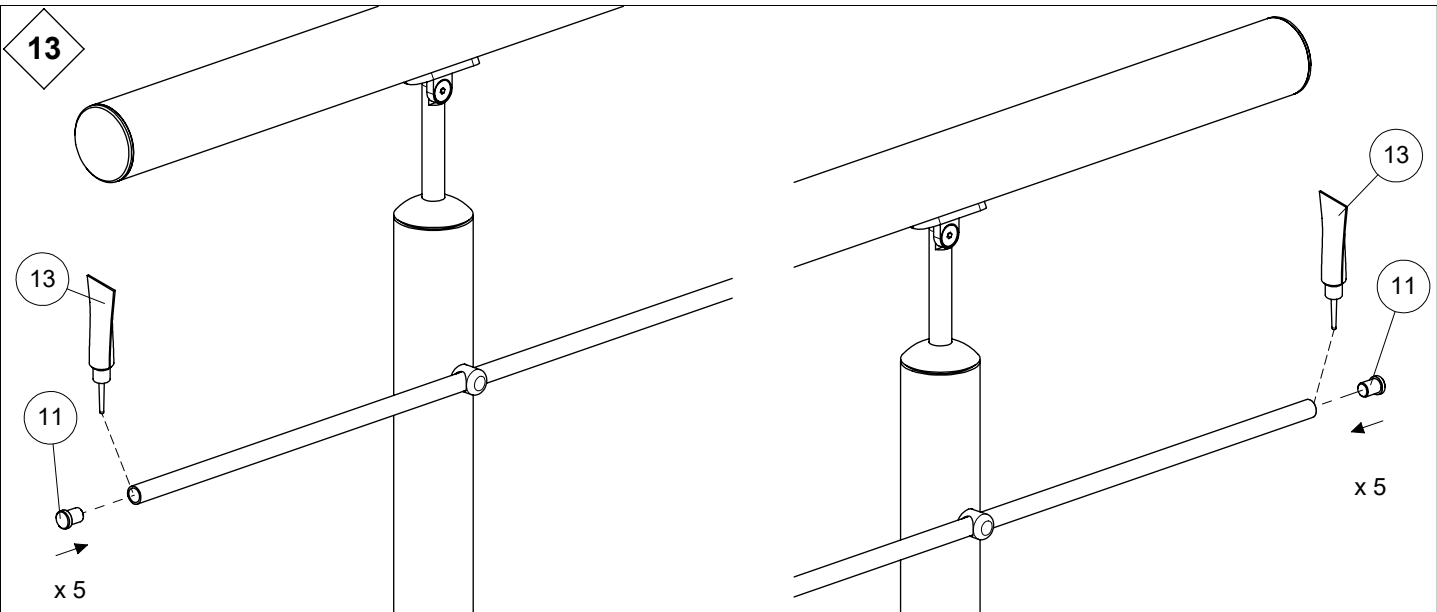
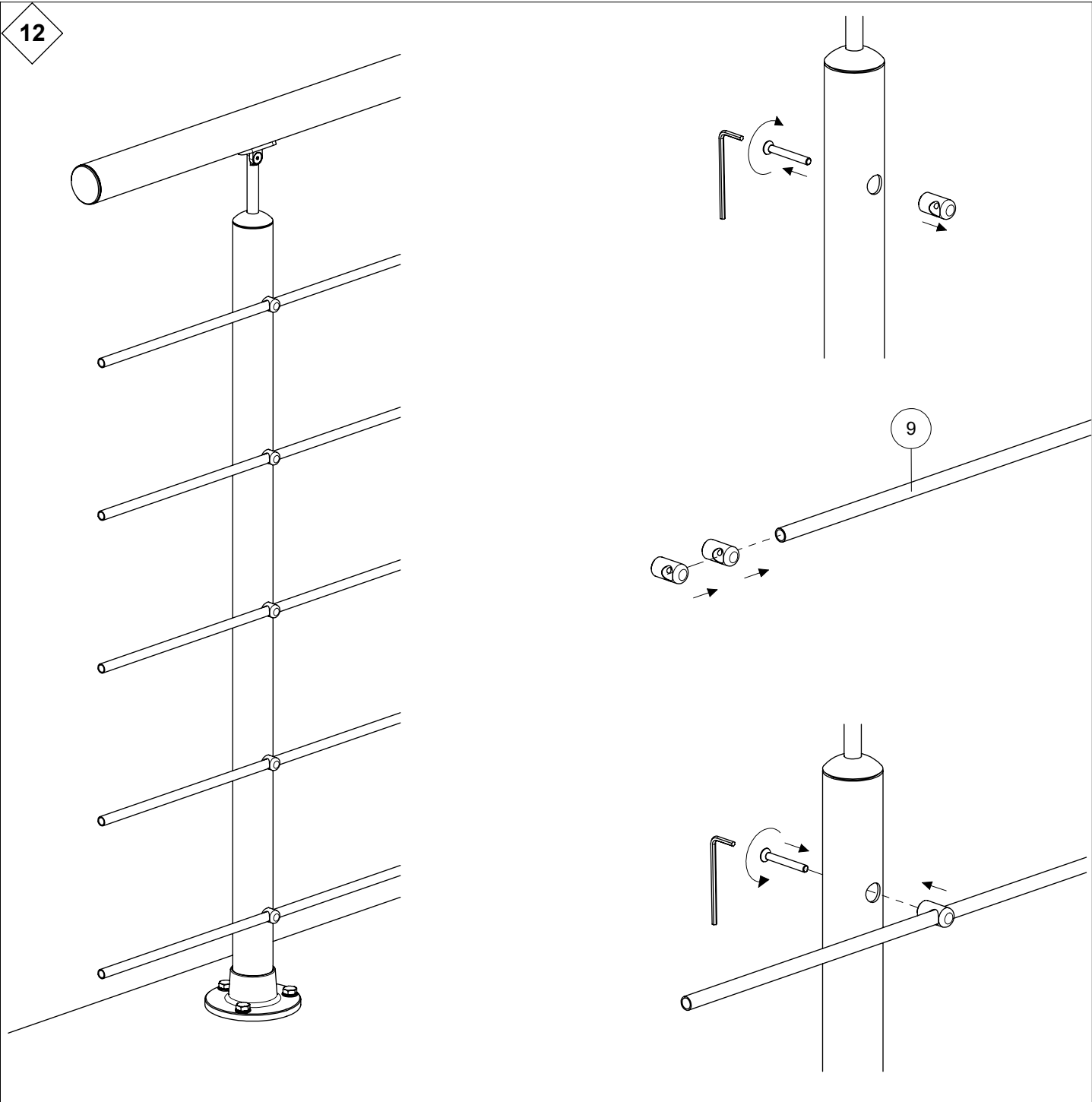

14 HIC
OPTION

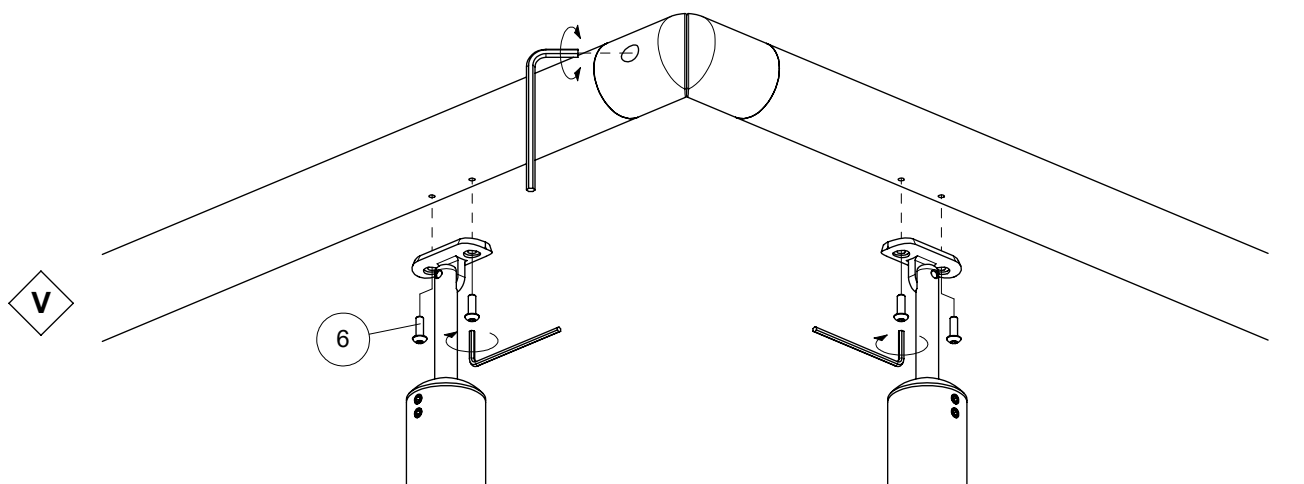
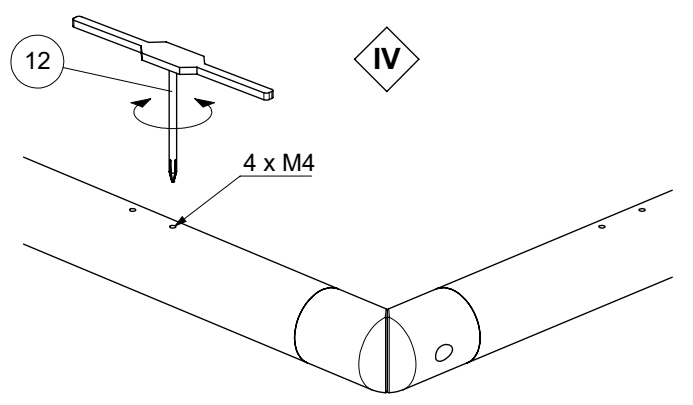
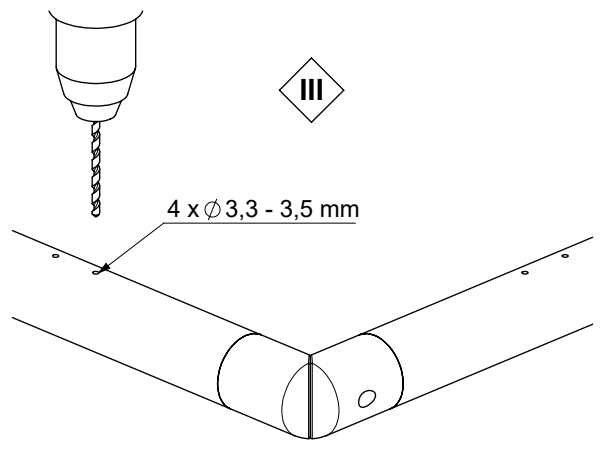
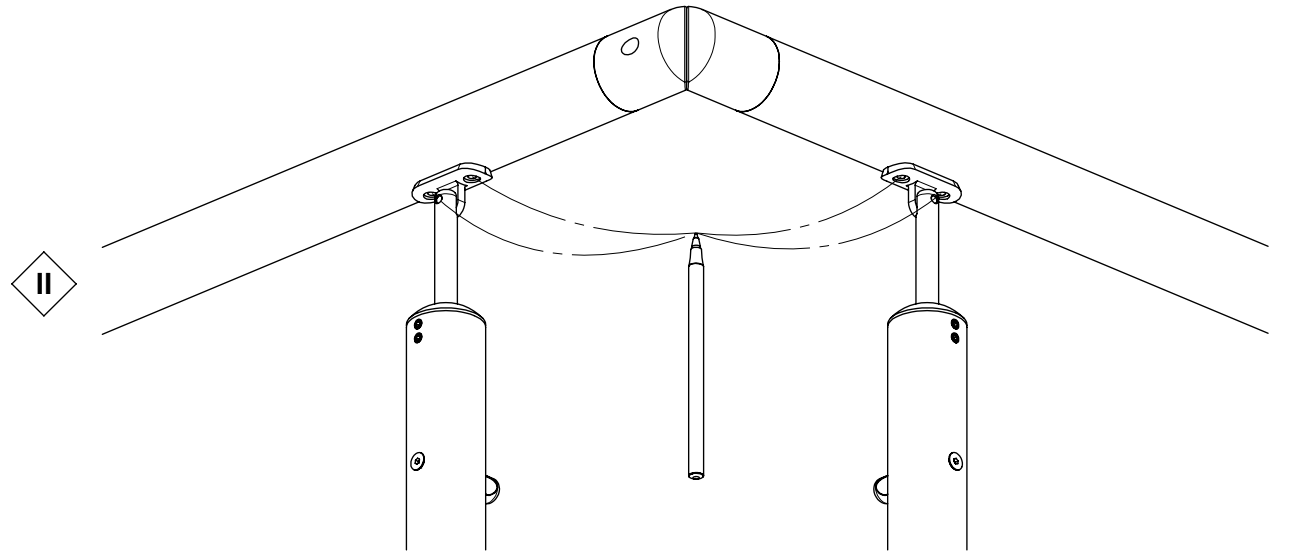
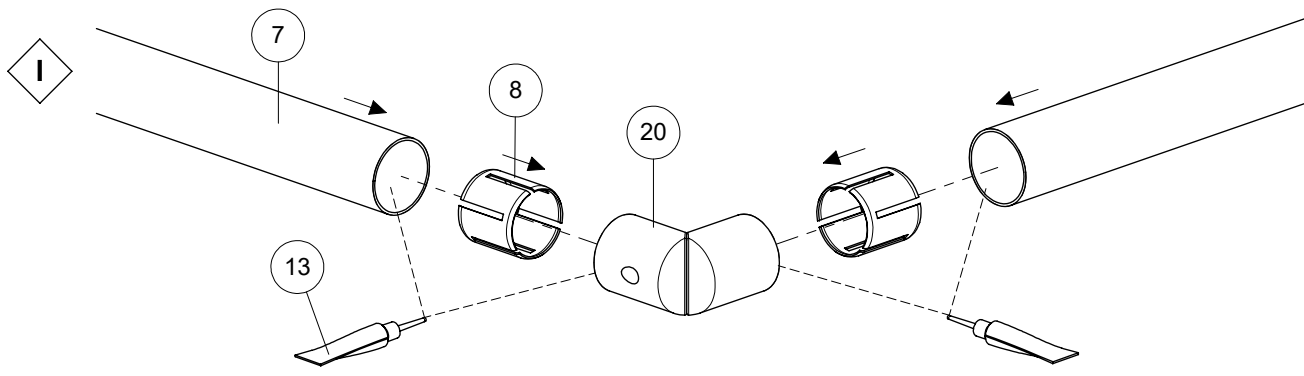

I

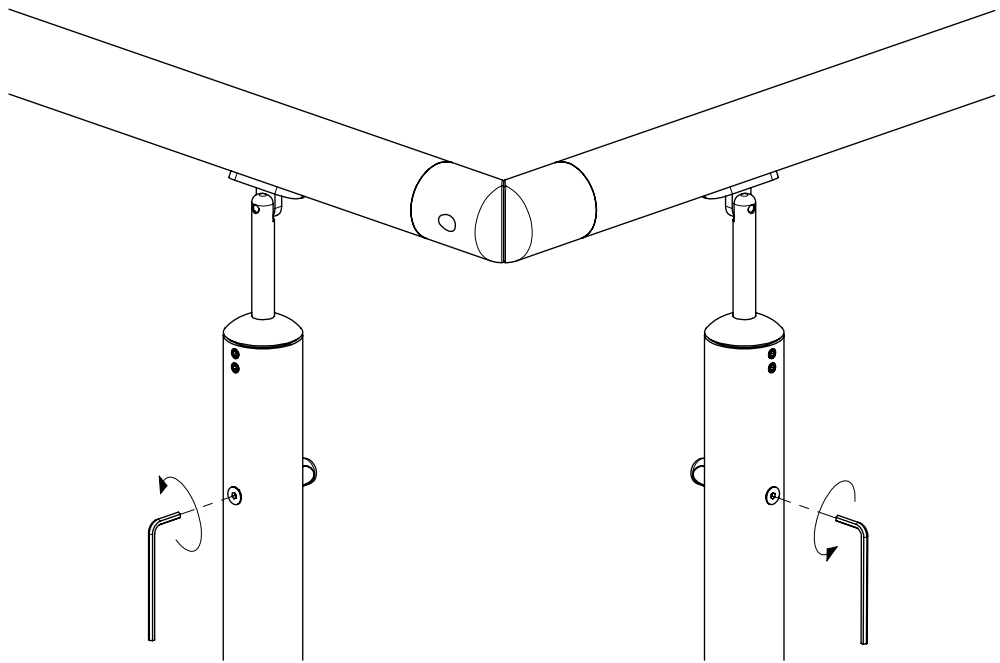

II

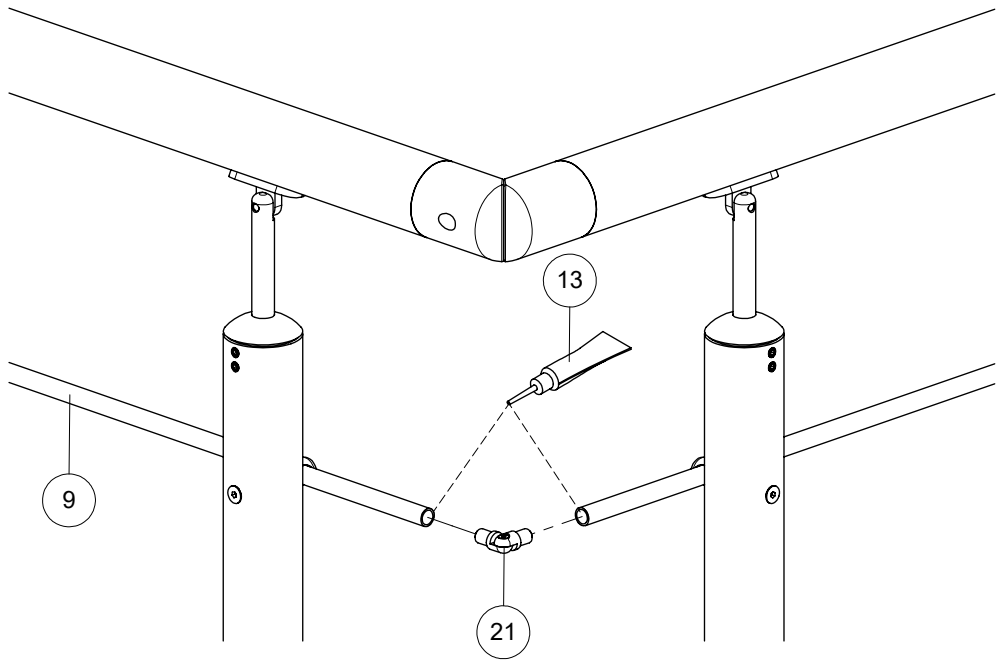

III

